

# PROPER CARE FOR YOUR TELESCOPE

## Collimating a Newtonian reflector

Collimation is the process of aligning the mirrors of your telescope so that they work in concert with each other to deliver properly focused light to your eyepiece. By observing out-of-focus star images, you can test whether your telescope's optics are aligned. Place a star in the centre of the field of view and move the focuser so that the image is slightly out of focus. If the seeing conditions are good, you will see a central circle of light (the Airy disc) surrounded by a number of diffraction rings. If the rings are symmetrical about the Airy disc, the telescope's optics are correctly collimated (Fig.j).

Fig.j

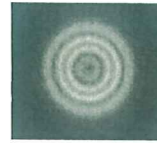

Correctly aligned



Needs collimation

Fig.j-1

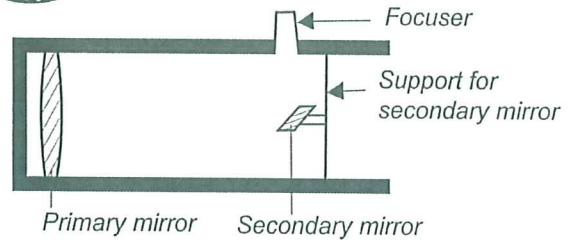

Fig.j-2

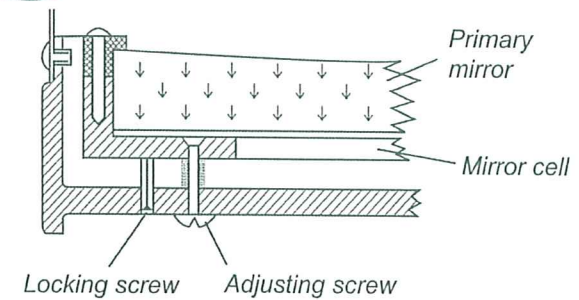

Fig.j-3

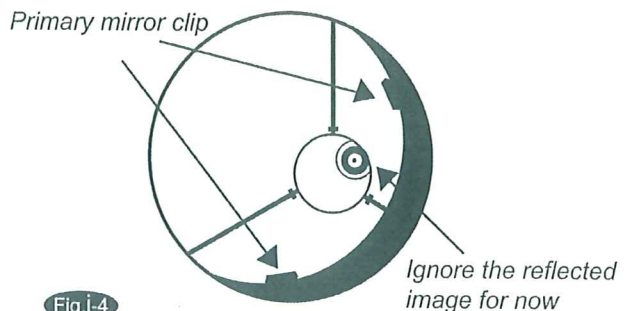
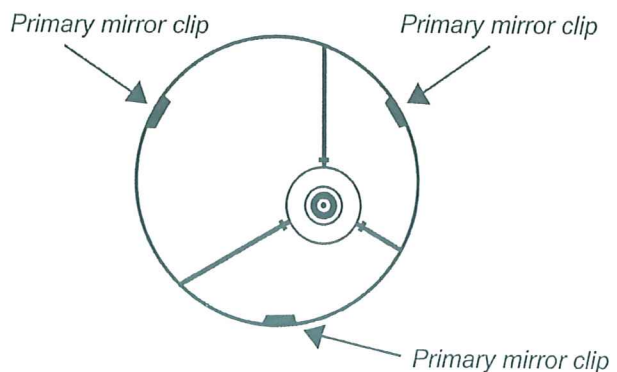

Fig.j-4



If you do not have a collimating tool, we suggest that you make a "collimating cap" out of a plastic 35mm film canister (black with gray lid). Drill or punch a small pinhole in the exact center of the lid and cut off the bottom of the canister. This device will keep your eye centered of the focuser tube. Insert the collimating cap into the focuser in place of a regular eyepiece.

Collimation is a painless process and works like this:

Pull off the lens cap which covers the front of the telescope and look down the optical tube. At the bottom you will see the primary mirror held in place by three clips 120° apart, and at the top the small oval secondary mirror held in a support and tilted 45° toward the focuser outside the tube wall (Fig.j-1).

The secondary mirror is aligned by adjusting the three smaller screws surrounding the central bolt. The primary mirror is adjusted by the three adjusting screws at the back of your scope. The three locking screws beside them serve to hold the mirror in place after collimation. (Fig.j-2)

### Aligning the Secondary Mirror

Point the telescope at a lit wall and insert the collimating cap into the focuser in place of a regular eyepiece. Look into the focuser through your collimating cap. You may have to twist the focus knob a few turns until the reflected image of the focuser is out of your view. Note: keep your eye against the back of the focus tube if collimating without a collimating cap. Ignore the reflected image of the collimating cap or your eye for now, instead look for the three clips holding the primary mirror in place. If you can't see them (Fig.j-3), it means that you will have to adjust the three bolts on the top of the secondary mirror holder, with possibly an Allen wrench or Phillip's screwdriver. You will have to

alternately loosen one and then compensate for the slack by tightening the other two. Stop when you see all three mirror clips (Fig.j-4). Make sure that all three small alignment screws are tightened to secure the secondary mirror in place.

### Aligning the Primary Mirror

Find the three locking screws at the back of your telescope and loosen them by a few turns.

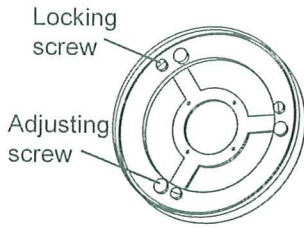

If you see 3 flat headed screws and 3 thumbscrews, the flat headed screws are the adjusting screws and the thumbscrews are the locking screws.



If you see 3 large nuts protruding from the back of your telescope and 3 small Phillip's-head screws besides them, the Phillip's-head screws are the locking screws and the large nuts are the adjusting screws.

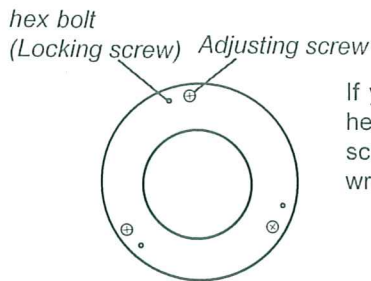

If you see 3 hex bolts and 3 Phillip's head screws, the hex bolts are the locking screws and the Phillip's-head screws are the adjusting screws. You will need an Allen wrench to adjust the locking screws.

Fig.j-5

Now run your hand around the front of your telescope keeping your eye to the focuser, you will see the reflected image of your hand. The idea here is to see which way the primary mirror is defocused; you do this by stopping at the point where the reflected image of the secondary mirror is closest to the primary mirrors' edge (Fig.j-5).

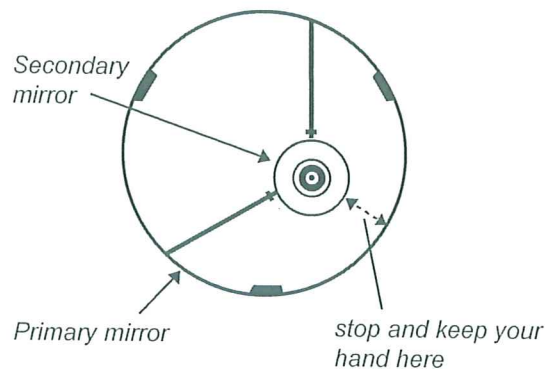

When you get to that point, stop and keep your hand there while looking at the back end of your telescope, is there an adjusting screw there? If there is you will want to loosen it (turn the screw to the left) to bring the mirror away from that point. If there isn't an adjusting screw there, then go across to the other side and tighten the adjusting screw on the other side. This will gradually bring the mirror into line until it looks like Fig.j-6. (It helps to have a friend to help for primary mirror collimation. Have your partner adjust the adjusting screws according to your directions while you look in the focuser.)

Fig.j-6

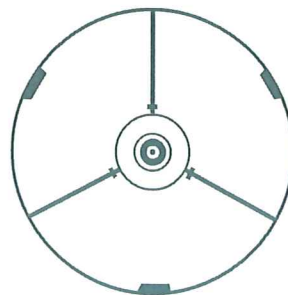

Both mirrors aligned with collimating cap in

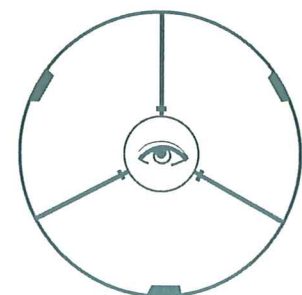

Both mirrors aligned with eye looking in focuser

After dark go out and point your telescope at Polaris, the North Star. With an eyepiece in the focuser, take the image out of focus. You will see the same image only now, it will be illuminated by starlight. If necessary, repeat the collimating process only keep the star centered while tweaking the mirror.